

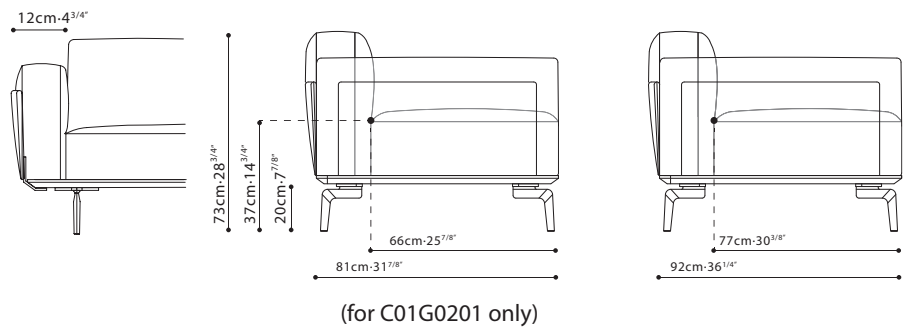

MODA / FRAME: The sofa under frame is constructed in solid Ash wood, covered in black eco-leather. The frame is reinforced with steel, layered with cross-woven elastic webbing and sinuous springs. **OUTER PANEL:** Outer sofa panel is constructed in steel, with choices of Eco-Leather or Leather. **CUSHION:** Detachable armrest, backrest and seat cushions are generously filled with high-resilient polyurethane foam, wrapped in compartmented feather down and polyester fiber. All cushions have hidden zipper closing. **LEGS:** Steel legs are finished in black metallic paint and capped with plastic glides. **UPHOLSTERY:** Available in all Fabric, all Leather, or Fabric + Leather combination upholstery. All covers are removable via Zipper.



FABRIC VERSION

C01G0201

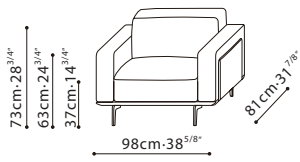

C01G0203

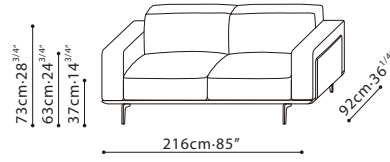

C01G0204

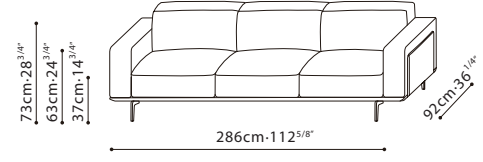

C01G0205

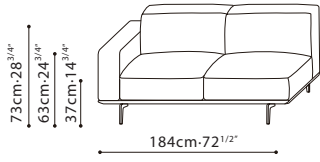

C01G0206

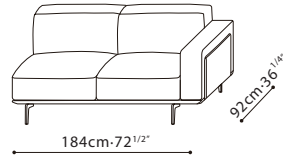

C01G0207

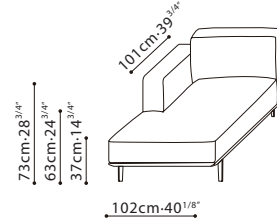

C01G0208

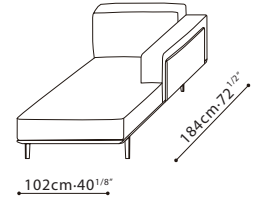

C01G0209

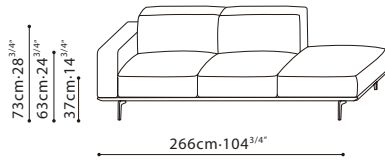

C01G0210

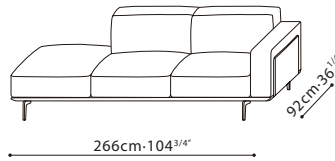

LEATHER VERSION

C01G0201

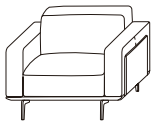

C01G0203

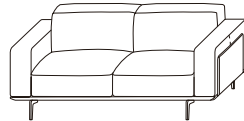

C01G0204



C01G0205

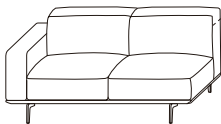

C01G0206



C01G0207

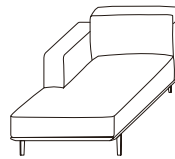

C01G0208

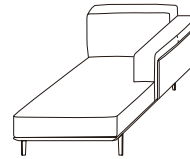

C01G0209



C01G0210



(dotted lines illustrate positioning of stitched seams on leather versions of this sofa)